

LEVELING AND STABILIZATION

NOTE: Part numbers are shown for identification purposes only. Not all parts are available for individual sale. All parts with a link to the Lippert Store can be purchased.

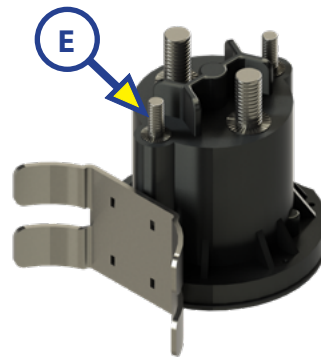
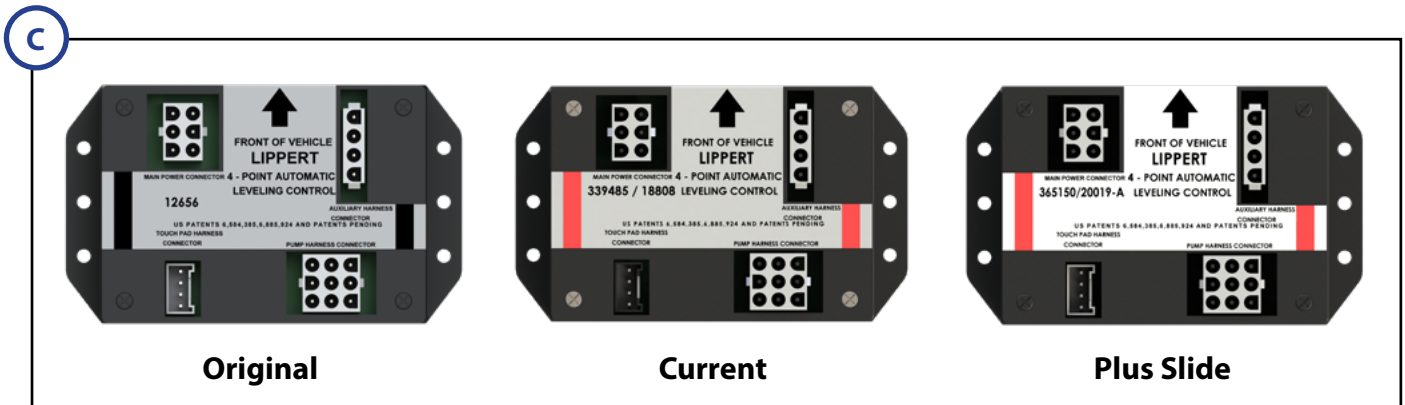

Callout	Part #	Description
A	175225	Touch Pad
B	182278	Ultra Level Touch Pad
C	175226	Controller (Original)
	339485	Controller (Current)
	365150	Controller (Plus Slide)
D	179327	Unidirectional Power Unit Motor
E	161394	Solenoid

LEVELING AND STABILIZATION

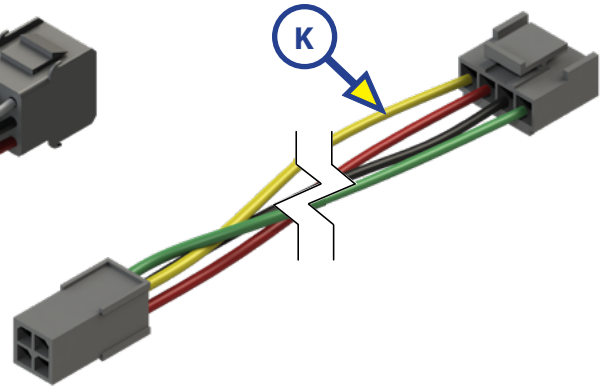
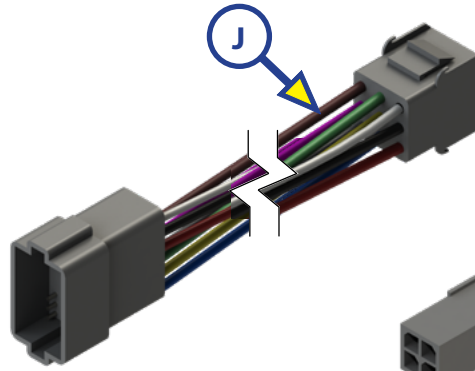
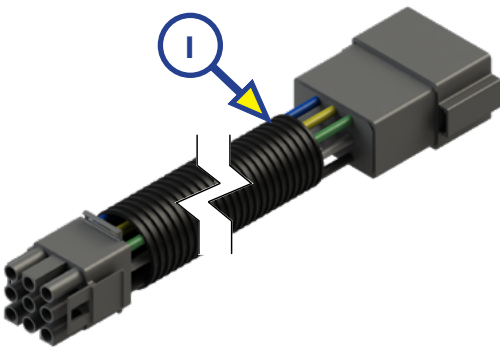
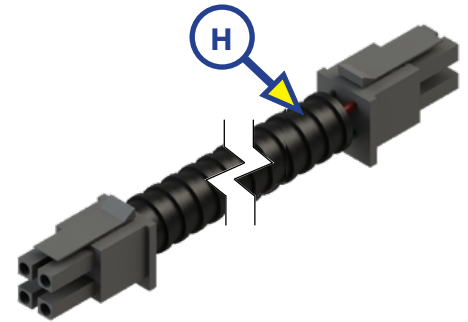
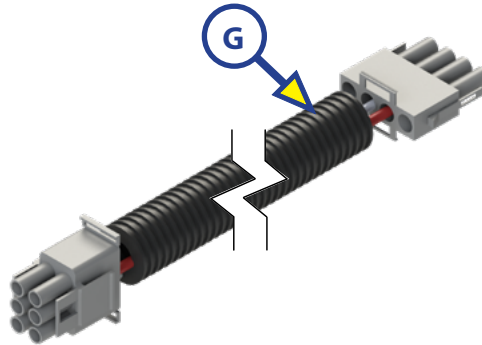
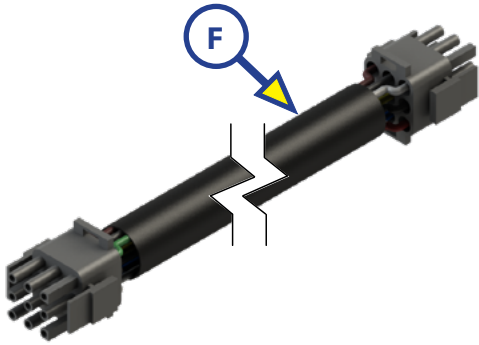

Callout	Part #	Description
F	140522	9-Pin Molex Harness
G	140524	36' Chassis Harness
H	140574	Ignition Harness
I	143322	9-Pin Molex to Deutsch Harness
J	167158	12-Pin Deutsch Harness
K	178278	Leveling Control Brain Wiring Harness

LEVELING AND STABILIZATION

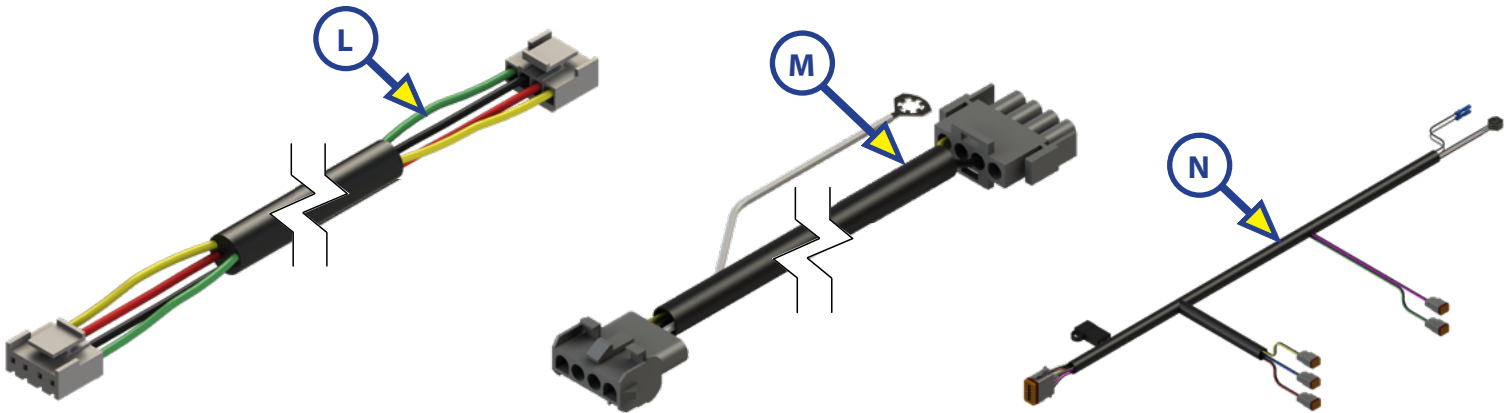

O

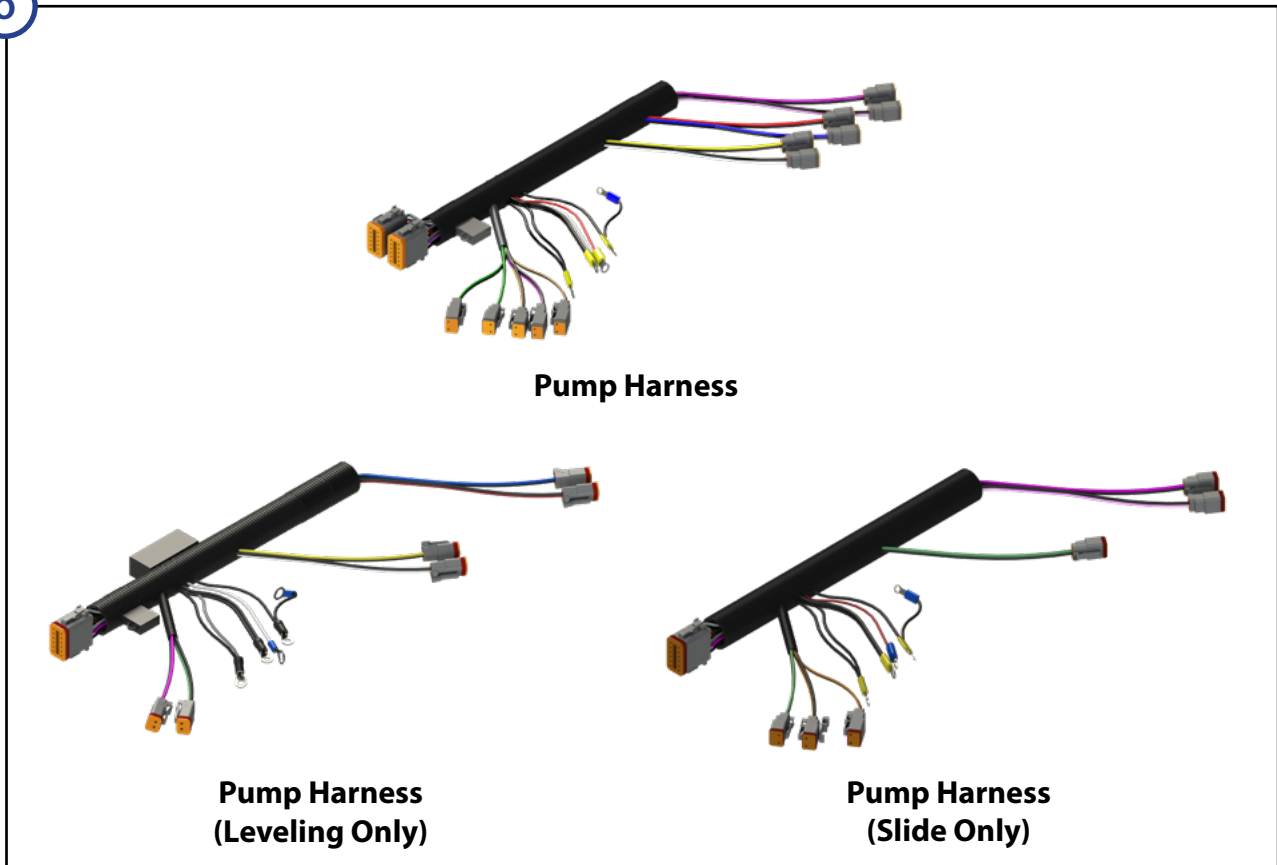

Callout	Part #	Description
L	178279	Touch Pad Harness
M	140636	6' Air Dump Harness
N	143324	Pump Harness w/ Deutsch Connector
O	162987	Pump Harness
	161400	Pump Harness (Leveling Only)
	161401	Pump Harness (Slide Only)

Unidirectional

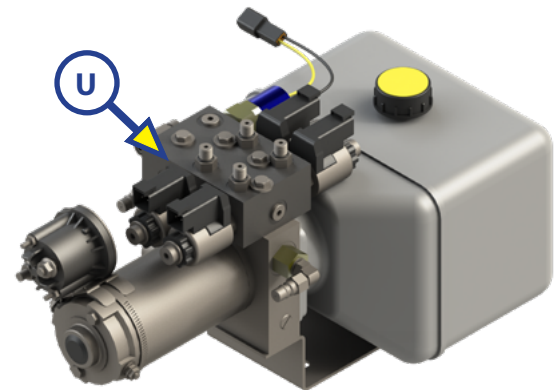
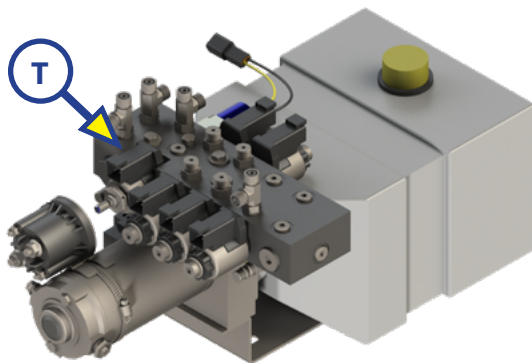
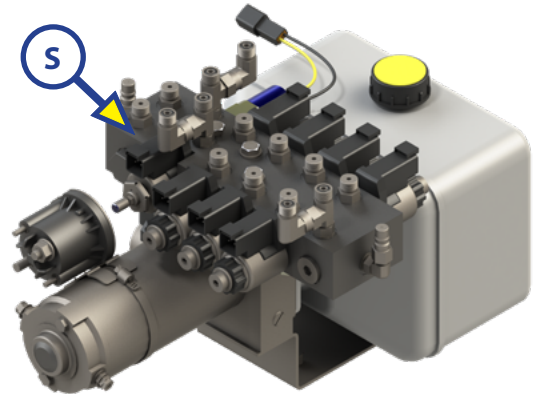
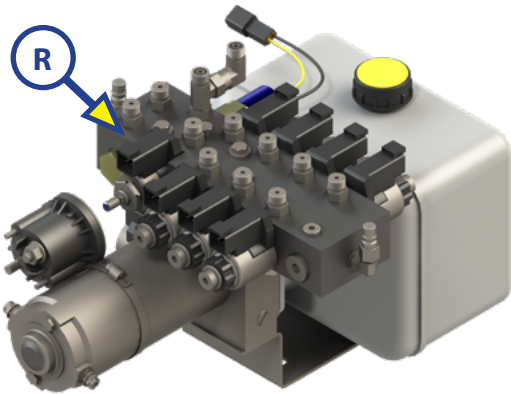
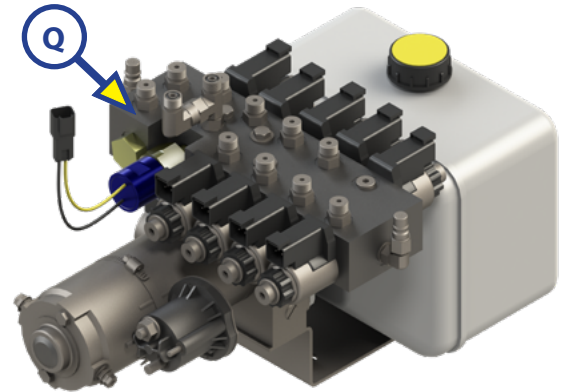
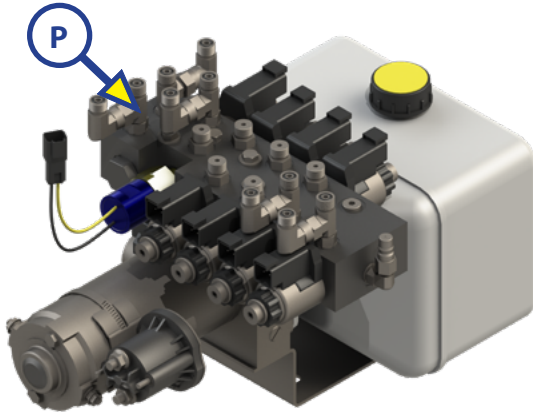

Callout	Part #	Description
NOTE: All unidirectional Power Units listed come with a harness.		
P	196894	Power Unit w/ Flow Divider; GT 378
Q	196895	Power Unit w/ Flow Divider; GT 357 QS
R	197249	Power Unit w/ Flow Divider; GT 340 RT LCI
S	211166	Power Unit w/ Flow Divider; GT 374
T	309890	Power Unit w/ Flow Divider; 7.5 Quart 1 Slide
U	309891	Power Unit; 5.5 Quart Leveling Only (Obsolete: Use 196471)

LEVELING AND STABILIZATION

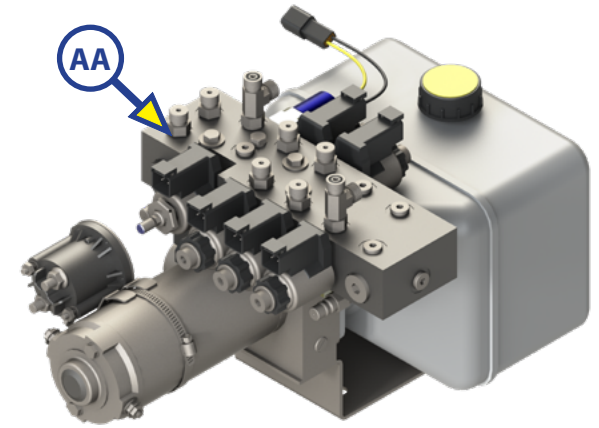
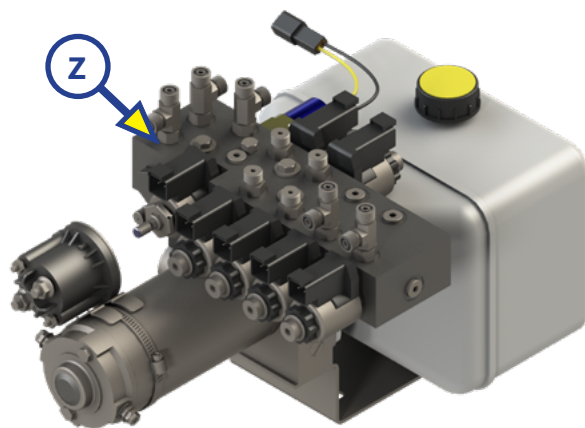
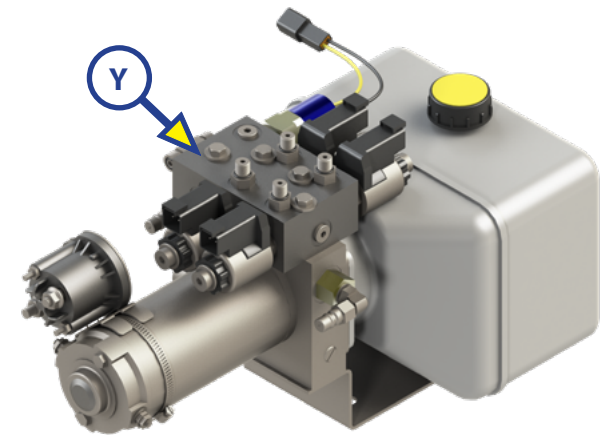
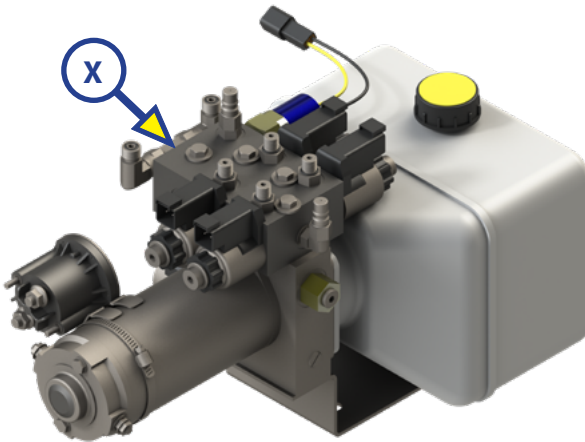
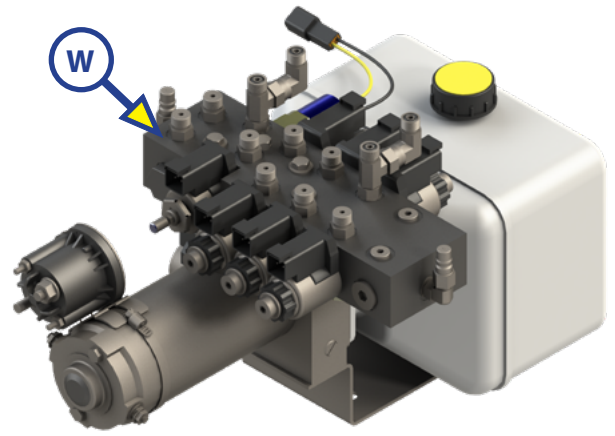
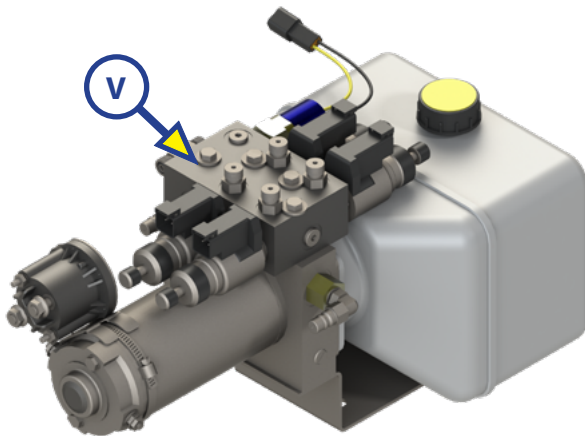

Callout	Part #	Description
V	196471	Power Unit; 4 Point Leveling Only
W	197248	Power Unit w/ Flow Divider; GT 359 WHREG RT LCI
X	218311	Power Unit; 1 Gallon Leveling Only
Y	172911	Power Unit; 8 Bank Manifold 4 Point Leveling Only (Obsolete: Use 196471)
Z	175248	Power Unit w/ Flow Divider; 8 Bank Manifold 4 Point with 2 Slides
AA	175249	Power Unit w/ Flow Divider; 8 Bank Manifold 4 Point with 1 Slide

LEVELING AND STABILIZATION

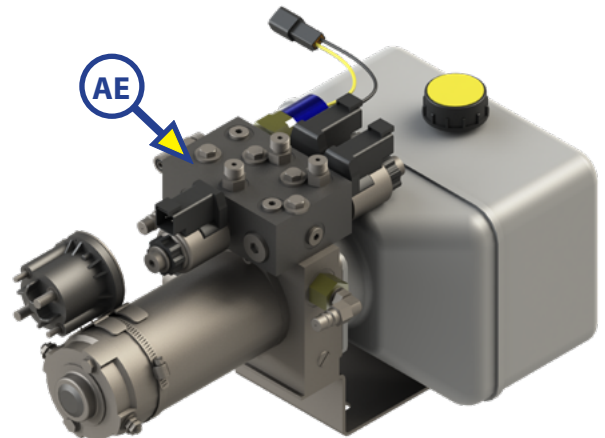
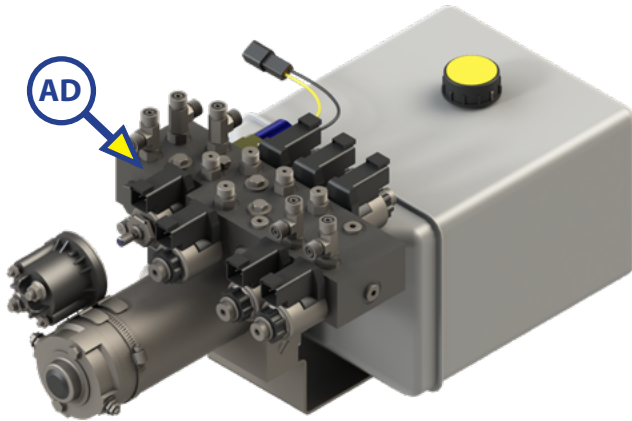
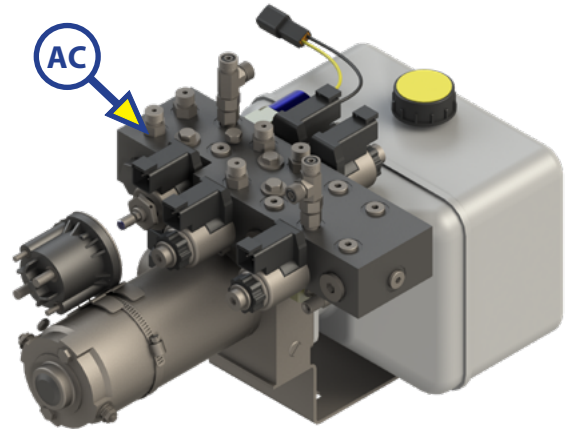
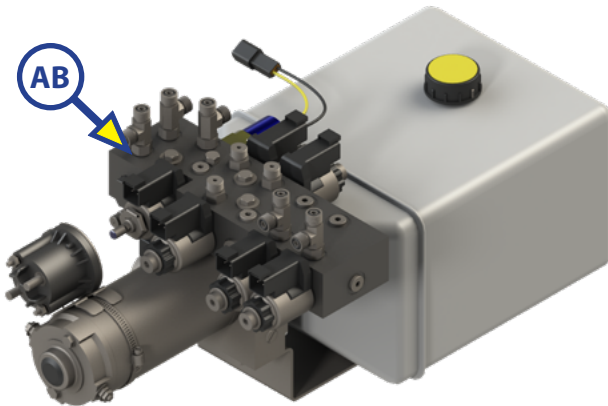

Callout	Part #	Description
AB	175250	Power Unit w/ Flow Divider; 8 Bank Manifold 3 Point with 2 Slides
AC	176474	Power Unit w/ Flow Divider; 3 Point Leveling with 1 Slide
AD	176687	Power Unit w/ Flow Divider; 3 Point Leveling with 3 Slides
AE	266379	Power Unit; 3 Point Leveling

LEVELING AND STABILIZATION

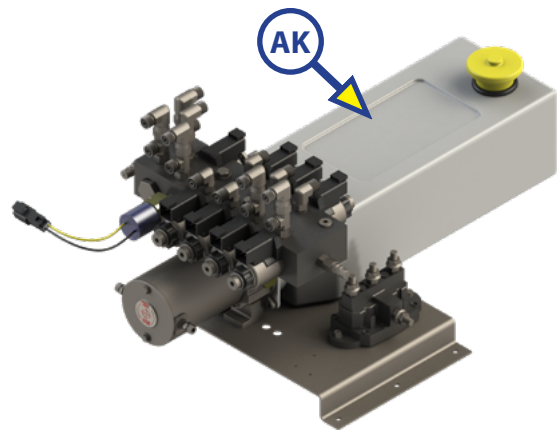
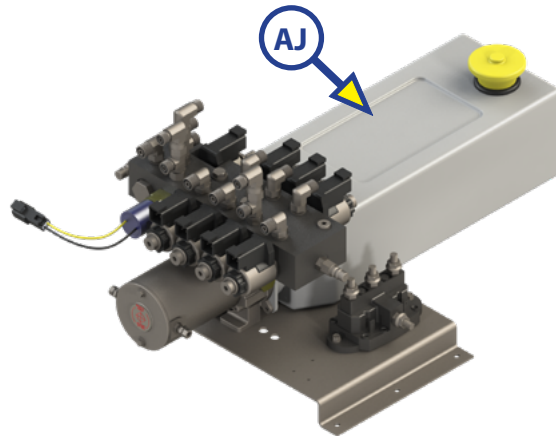
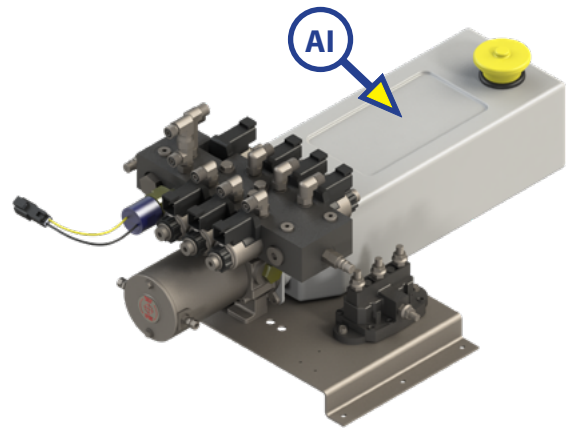
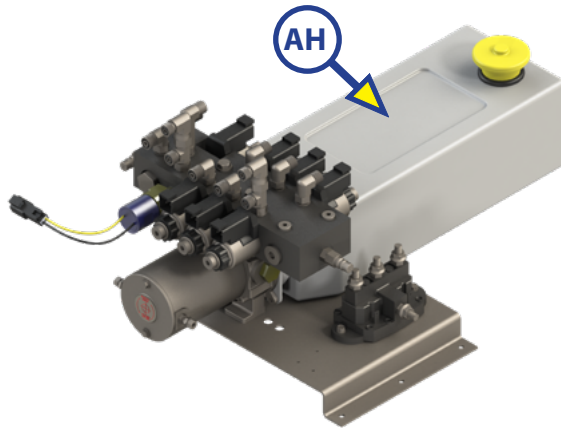
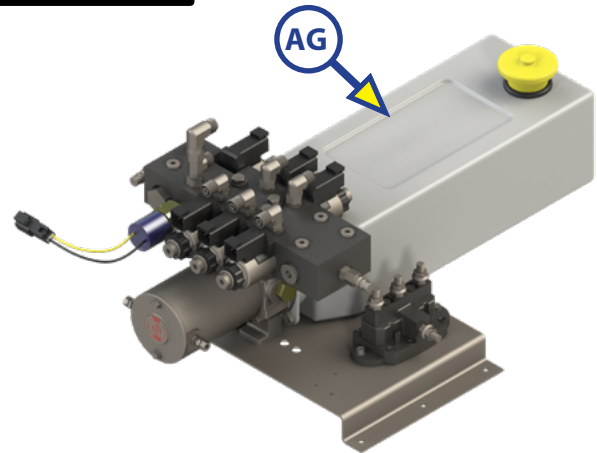
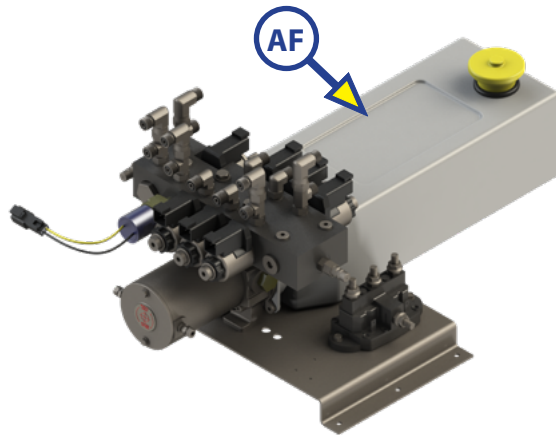

Callout	Part #	Description
AF	145941	Power Unit w/ Flow Divider; Leveling with 2 Slides, GT(373)
AG	149083	Power Unit w/ Flow Divider; Leveling with 1 Slide, GT(338)
AH	149084	Power Unit w/ Flow Divider; Leveling with 2 Slides, GT(359RE, 323, 326, 342, 359, 370)
AI	149085	Power Unit w/ Flow Divider; Leveling with 2 Slides, GT(315, 350)
AJ	149086	Power Unit w/ Flow Divider; Leveling with 3 Slides, GT(319, 391)
AK	149087	Power Unit w/ Flow Divider; Leveling with 3 Slides, GT(349, 375, 378)

LEVELING AND STABILIZATION

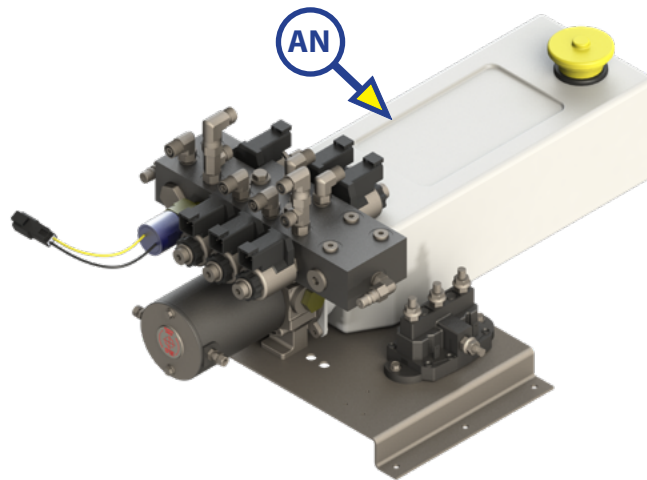
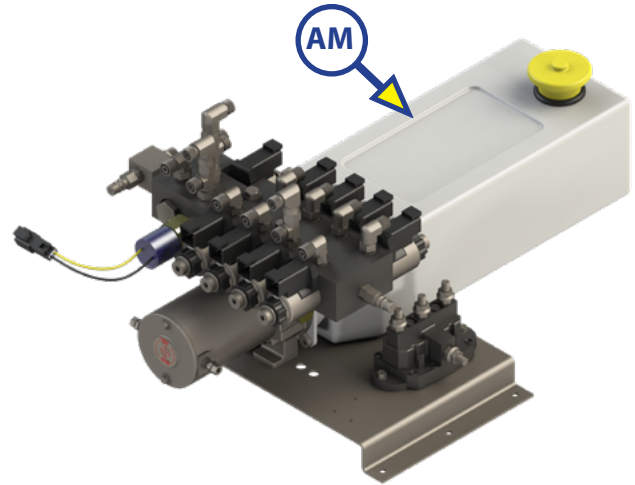
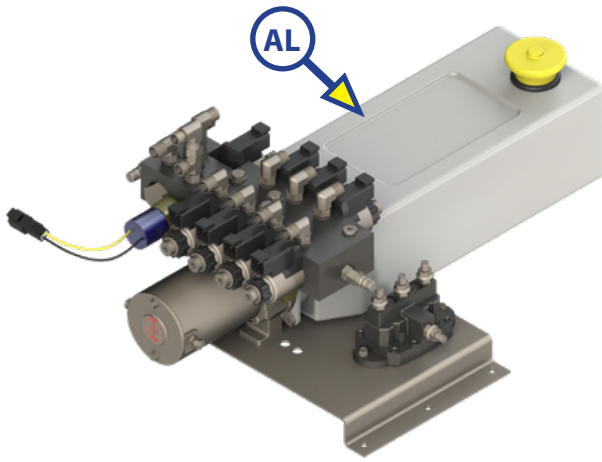

Callout	Part #	Description
AL	149088	Power Unit w/ Flow Divider; GT(340, 350B)
AM	179866	Power Unit w/ Flow Divider; Leveling with 4 Slides
AN	141663	Power Unit w/ Flow Divider; Leveling with 1 Slides

Bi-Rotational

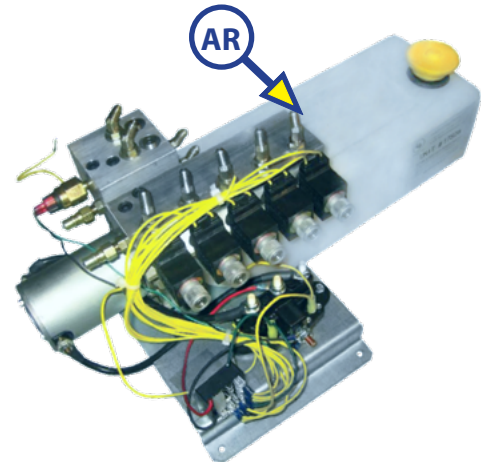
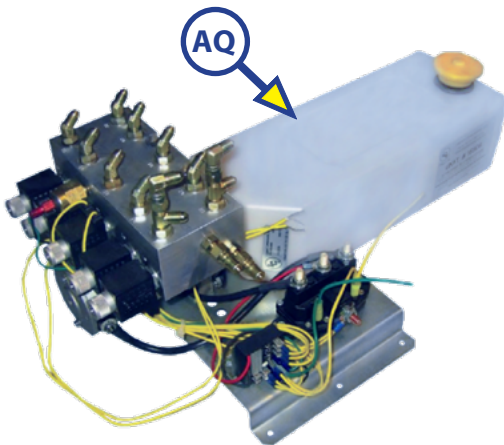
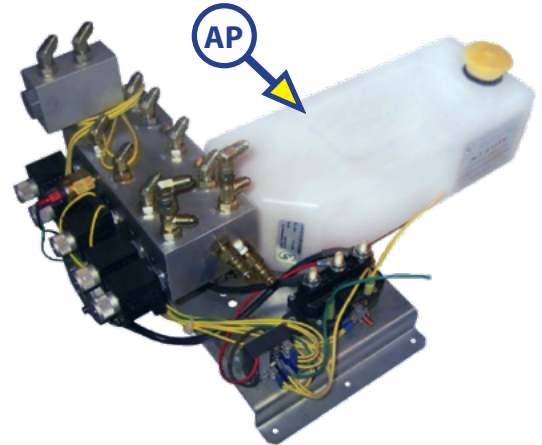
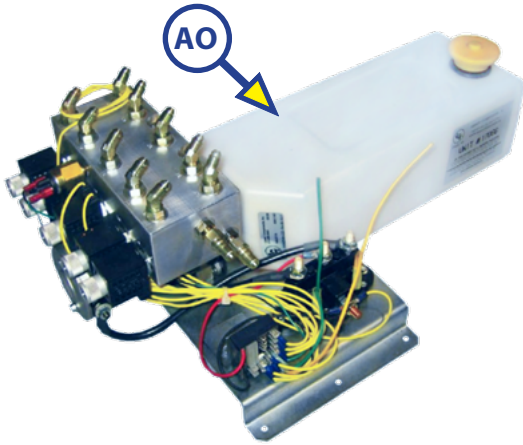

Callout	Part #	Description
AO	146374	Power Unit; Leveling with 1 Slide
AP	146375	Power Unit w/ Flow Divider; Leveling with 2 Slides
AQ	146376	Power Unit; Leveling with 2 Slides
AR	146377	Power Unit; Inline Leveling with 1 Slide

LEVELING AND STABILIZATION

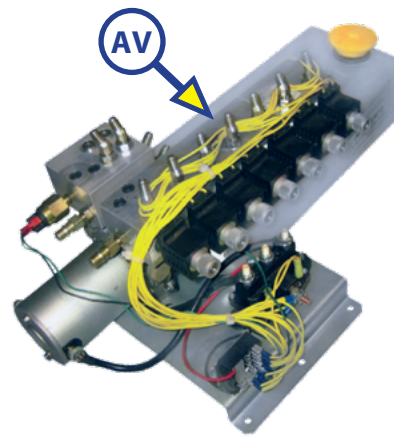
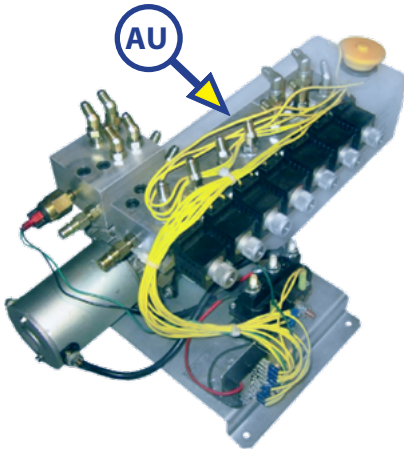
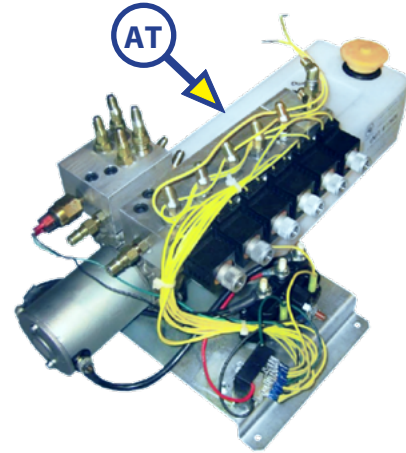
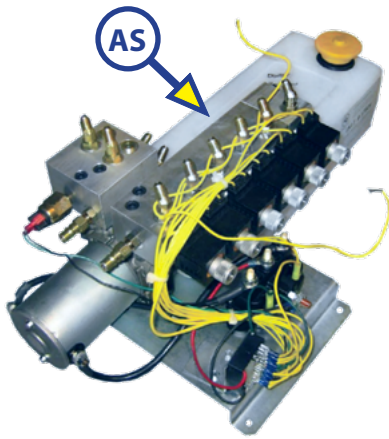

Callout	Part #	Description
AS	146378	Power Unit; Inline Leveling with 2 Slides
AT	146379	Power Unit w/ Flow Divider; Inline Leveling with 2 Slides
AU	146380	Power Unit w/ Flow Divider; Inline Leveling with 3 Slides
AV	146381	Power Unit; Inline Leveling with 3 Slides

LEVELING AND STABILIZATION



Callout	Part #	Description
AW	113314	7,000 High Jack Steel
AX	117179	7,000 Low Jack Steel
AY	175176	12,000 High Jack Steel
AZ	175630	12,000 Low Jack Steel
BA	176806	22,000 High Jack Steel
BB	176805	22,000 Low Jack Steel
BC	115842	22,000 Jack Steel

8K Jacks

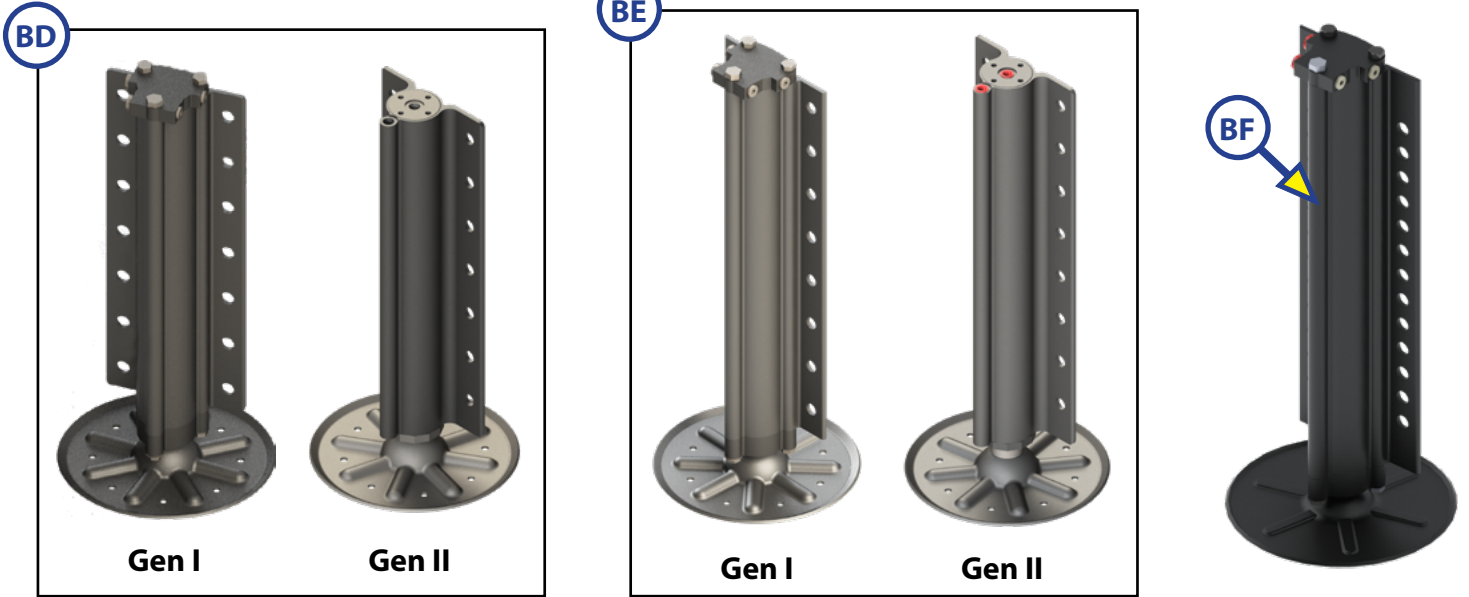

Callout	Part #	Description
BD	336066	Mini 8K Jack (Gen I)
	708459	Mini 8K Jack (Gen II)
BE	195860	8K Jack, 8 Hole Black (Gen I)
	372892	8K Jack, 8 Hole Black (Gen II)
	1958604	8K Jack, 8 Hole Silver (Gen I)
	8005303	8K Jack, 8 Hole Silver (Gen II)
BF	433458	8K Jack, 13 Hole Black (Gen I)
	43345810	8K Jack, 13 Hole Silver (Gen I)

LEVELING AND STABILIZATION

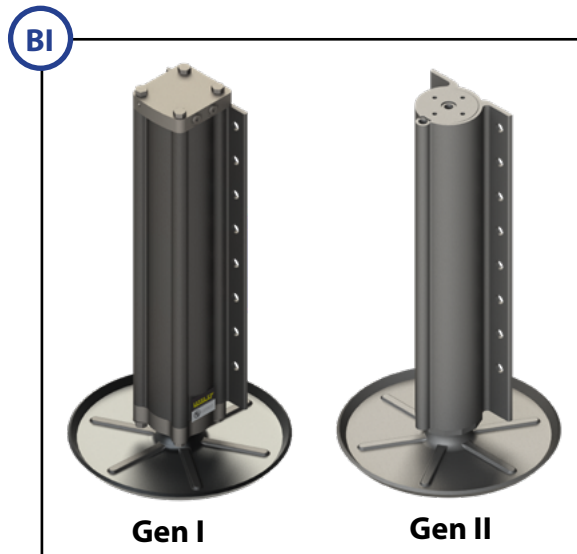

Callout	Part #	Description
BG	236560	14K Jack, 8 Hole Black (Gen I)
	2365601	14K Jack, 8 Hole Silver (Gen I)
	333866	14K Jack, 8 Hole (Gen II)
BH	433464	14K Jack, 14 Hole Black (Gen I)
	43346410	14K Jack, 14 Hole Silver (Gen I)
BI	258550	20K Jack, 8 Hole Black (Gen I)
	2585501	20K Jack, 8 Hole Silver (Gen I)
	339638	20K Jack, 8 Hole (Gen II)
BJ	433472	20K Jack, 15 Hole Black (Gen I)

LEVELING AND STABILIZATION

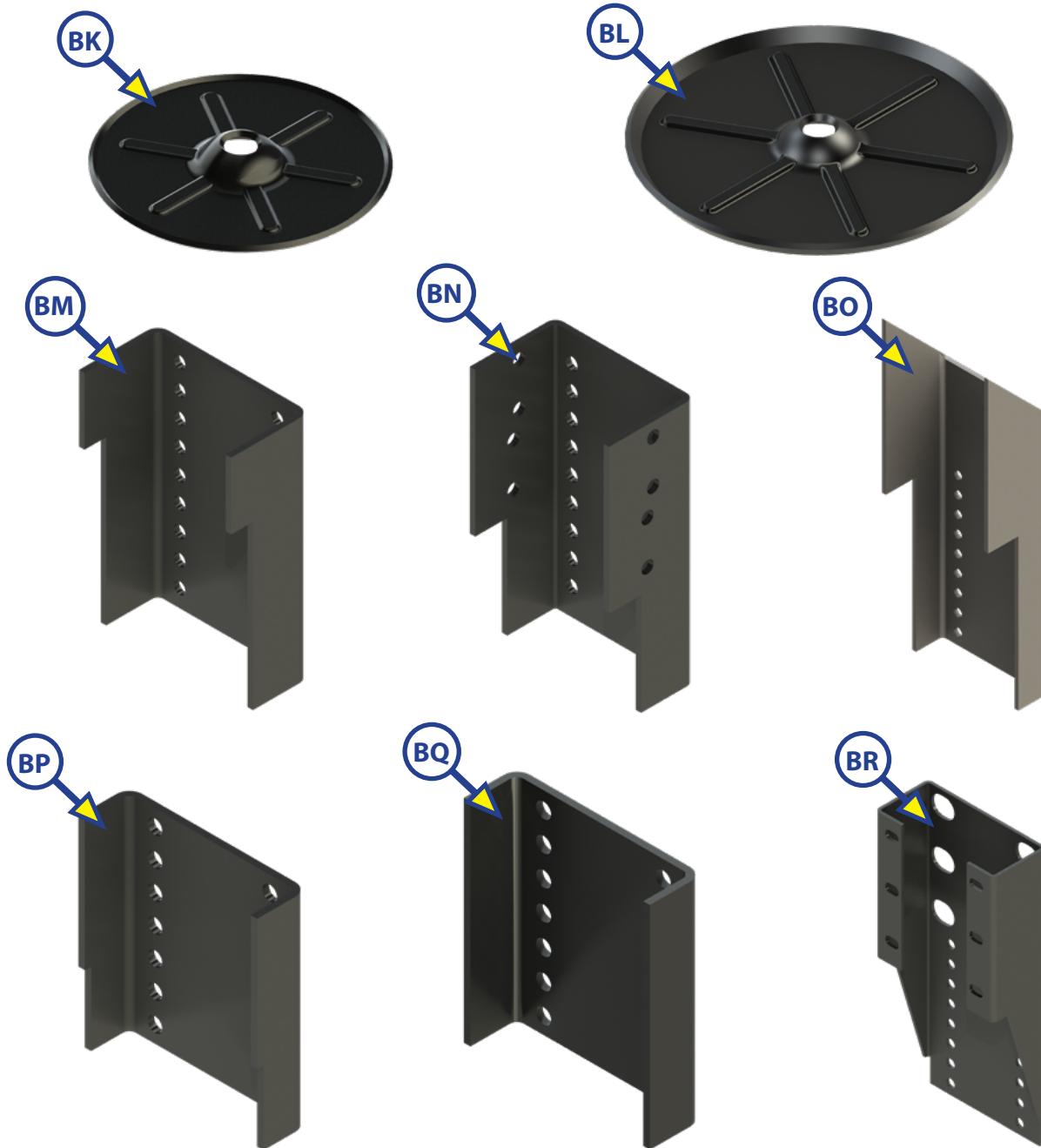

Callout	Part #	Description
BK	113309	9" Footpad for Leveling Jacks
BL	1172381	12" Footpad for Leveling Jacks (Optional)
BM	115567	Weld-On Jack Mounting Bracket (Obsolete)
BN	116471	Weld-On Jack Mounting Bracket
BO	134989	Weld-On Jack Mounting Bracket
BP	162349	Weld-On Jack Mounting Bracket (Obsolete)
BQ	100345	Weld-On Jack Mounting Bracket
BR	1170591	Bolt-On Jack Mounting Bracket

LEVELING AND STABILIZATION

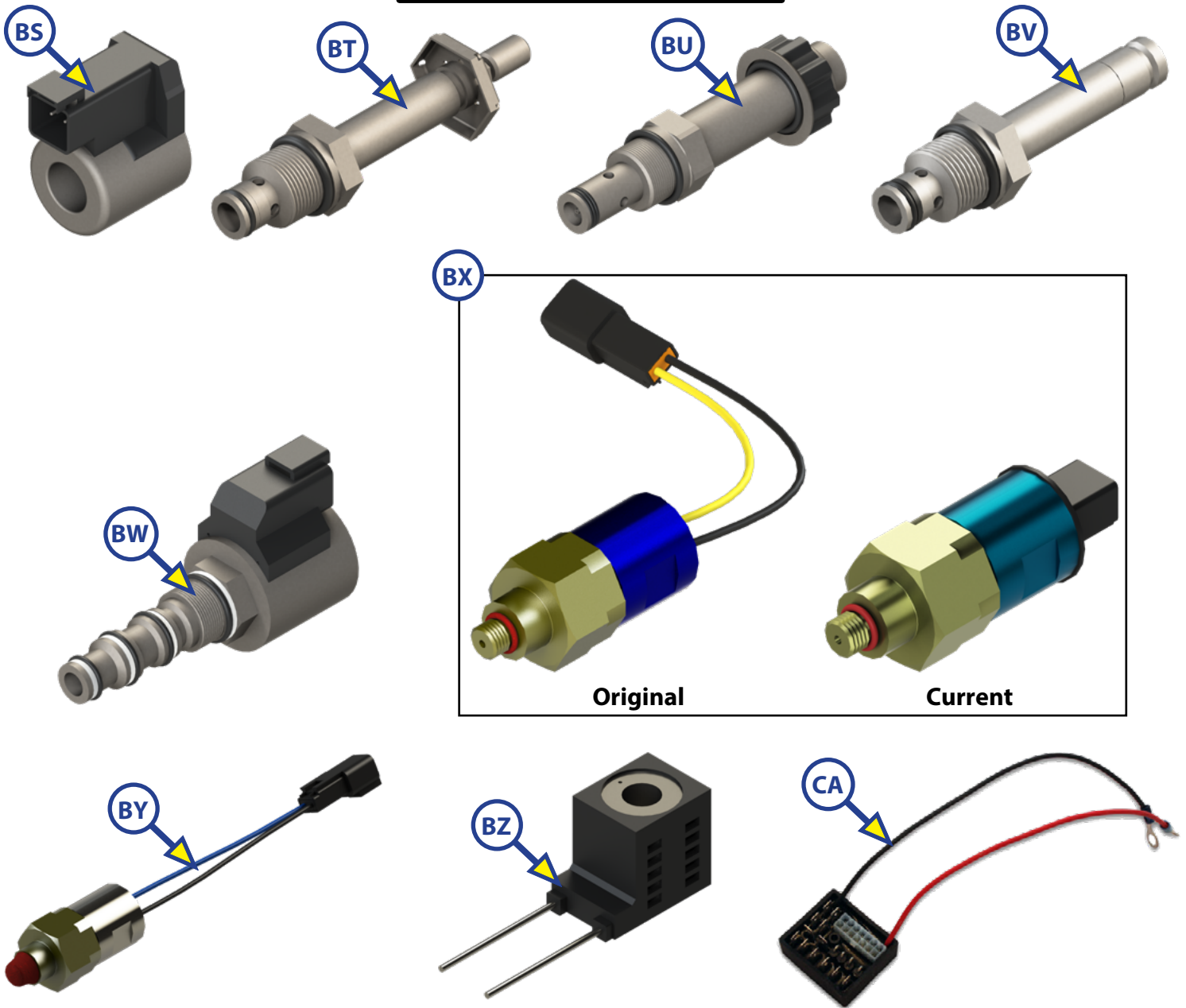

Callout	Part #	Description
BS	174184	12 Volt Deutsch Style Coil (Hydac)
BT	140571	Isolator Valve (Flow Divider)
BU	177094	Cartridge (Hydac) Valve
BV	140538	Deltrol Valve
BW	259524	Unidirectional 4-Way Valve (Obsolete)
BX	142927	Pressure Switch (2150 PSI) (Original)
		Pressure Switch (2150 PSI) (Current)
BY	159321	Pressure Switch (2350 PSI)
BZ	140559	Deutsch Flying Lead (Obsolete)
CA	113782	Suppression Module

LEVELING AND STABILIZATION

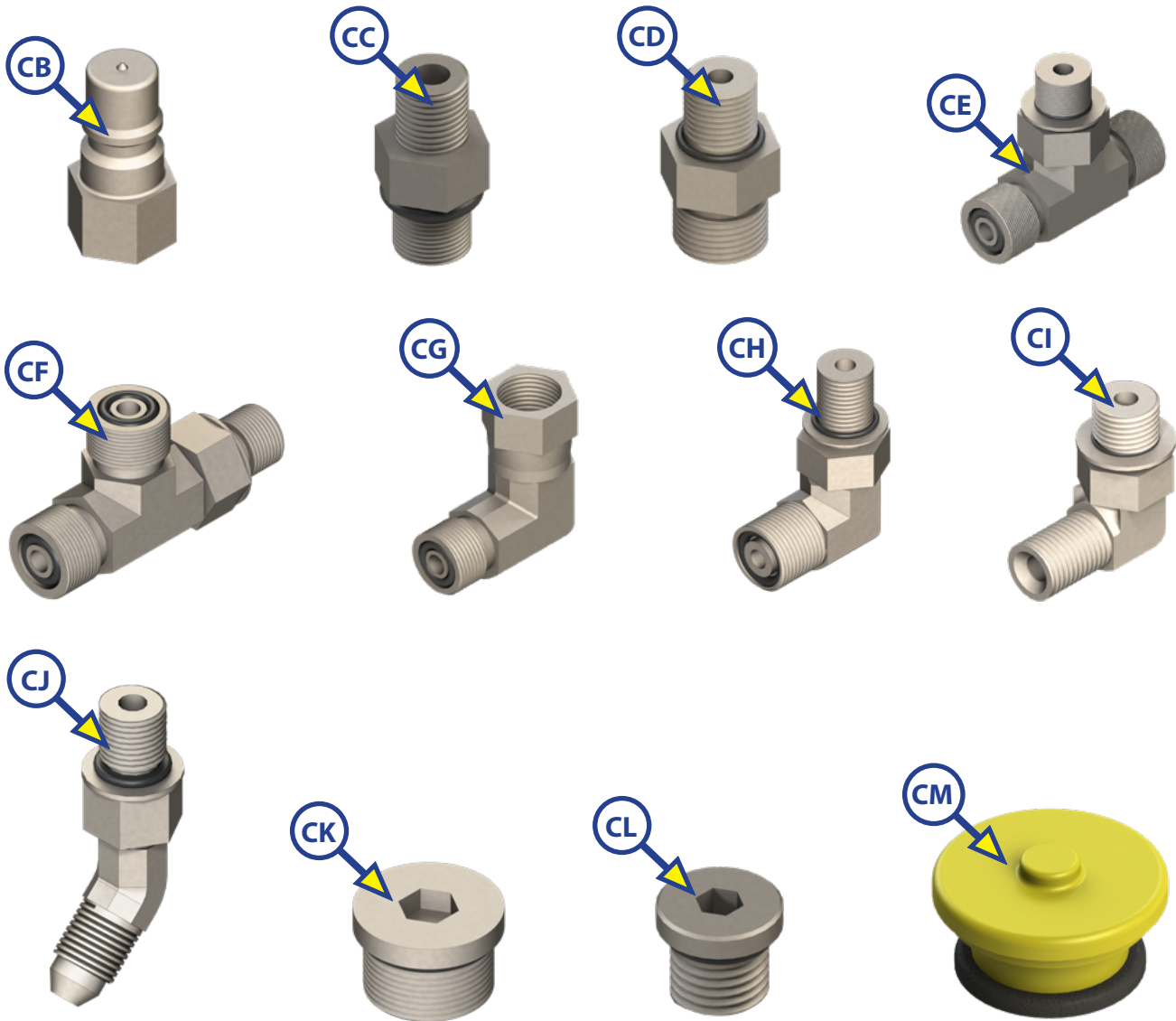

Callout	Part #	Description
CB	140457	Quick Disconnect Fitting
CC	141321	O-Ring to Pipe Straight Reducer Fitting
CD	141109	Straight Face Seal Fitting
CE	143108	Branch T-Fitting
CF	141087	Face Seal T-Fitting
CG	156846	Swivel Face Seal Elbow 90 Degree Fitting
CH	141610	Face Seal Elbow 90 Degree Fitting
CI	141331	Elbow 90 Degree Fitting
CJ	113129	1/4" Hydraulic 45 Degree Fitting
CK	141323	1/2" Hex Plug
CL	140998	1/4" Hex Plug
CM	157505	Fill Cap